

Versione	Simbolo	Tipo
Corpo e vite di regolazione in ottone		
Vite con regolazione a cacciavite		V15
Vite con regolazione a manopola		V14
Orientabile con regolazione a cacciavite e occhio con filetto femmina		V17
Orientabile con regolazione a manopola e occhio con filetto femmina		V40
Girevole con regolazione a cacciavite e occhio con innesto rapido		V18
Girevole con regolazione a manopola e occhio con innesto rapido		V41
Girevole con regolazione a cacciavite e occhio con attacco a calzamento		V20
Corpo in Delrin e vite di regolazione in ottone		
Orientabile con regolazione a cacciavite e occhio con innesto rapido		V39
Orientabile con regolazione a manopola e occhio con innesto rapido		V37
Girevole con regolazione a cacciavite e occhio con innesto rapido		V38
Girevole con regolazione a manopola e occhio con innesto rapido		V36



Serie di regolatori di portata normalmente applicati direttamente sulle connessioni dei cilindri, per il controllo della velocità della traslazione.

Fornibili con diverse funzioni: unidirezionali con regolazione in uscita (C), unidirezionali con regolazione in entrata (V) e bidirezionali con regolazione in entrambi i sensi (B).

Per ottenere un controllo preciso della velocità del cilindro è consigliata l'applicazione di due regolatori unidirezionali con regolazione in uscita (C), che agiscono sul flusso in scarico dalle camere del cilindro stesso e non interferiscono sul flusso in entrata verso le camere.

* Esempio d'ordine: V180618C

V18	06	18	C
Tipo	Sigla filetto o tubo	Sigla filetto	Sigla funzione

* Per gli articoli standard, codici e dimensioni vedi tabelle da pag. 4.80.12.

Per le portate vedi diagrammi pag 4.80.30

Ø tubo esterno (mm)	4	6	8	10	12	14
Sigla	04	06	08	10	12	14
Filetti	M5	1/8"	1/4"	3/8"	1/2"	
Sigla	M5	18	14	38	12	
Funzione	Per cilindro	Per valvola	Bidirezionale			
Sigla	C	V	B			

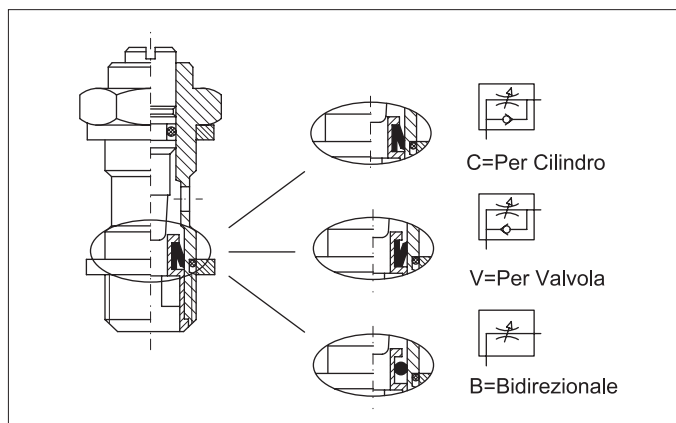

Caratteristiche tecniche	
Fluido	Aria compressa filtrata con o senza lubrificazione
Pressione	0,5 ÷ 10 bar
Temperatura	-20 °C ÷ +70 °C
Filettature	Cilindriche UNI - ISO 228/1 (BSP) - Metriche: ISO R / 262
Tubi di collegamento	Nylon, poliuretano e Rilsan calibrati
Tolleranze tubi	± 0,05 mm
Materiali	Vite di regolazione: Ottone nichelato Corpo: Ottone nichelato / resina acetalica Guarnizioni: Gomma nitrilica (NBR)

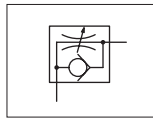
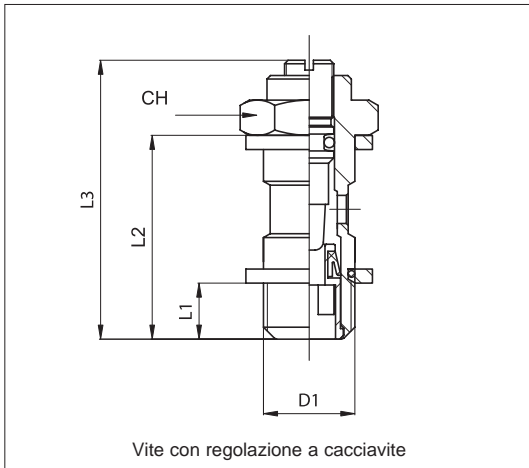

Per cilindro

Codice	Articolo	D ₁	L ₁	L ₂	L ₃ max	CH	gr.
024021	V15 00 M5C	M5	4	16	23,5	8	5
024022	V15 00 18C	1/8"	6	25	36	14	16
024023	V15 00 14C	1/4"	8	29	42	17	32
024024	V15 00 38C	3/8"	9	33	52	20	59
024025	V15 00 12C	1/2"	10	39	61	26	108

Per ocelli innesto rapido serie R
Per ocelli innesto rapido serie RT
Per ocelli a calzamento serie C
Per ocelli ad ogiva serie O
Per ocelli standard serie A

vedi pagina 4.2.9.
vedi pagina 4.5.7.
vedi da pag. 4.20.7.
vedi pag. 4.25.5.
vedi pag. 4.35.9.

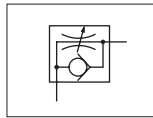
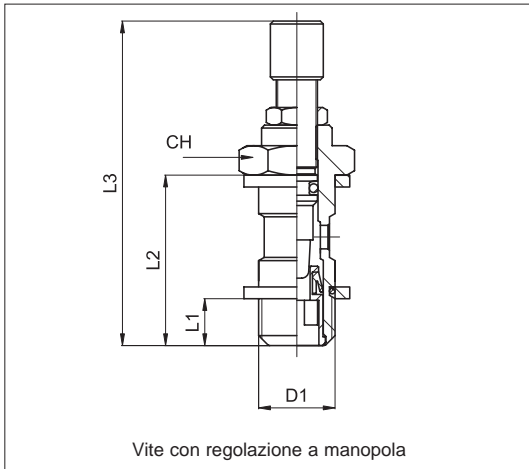

Per cilindro

Codice	Articolo	D ₁	L ₁	L ₂	L ₃ max	CH	gr.
024026	V14 00 M5C	M5	4	16	38,5	8	7
024027	V14 00 18C	1/8"	6	25	50	14	22
024028	V14 00 14C	1/4"	8	29	58	17	38
024029	V14 00 38C	3/8"	9	33	72	20	67
024030	V14 00 12C	1/2"	10	39	81	26	121

Per ocelli innesto rapido serie R
Per ocelli innesto rapido serie RT
Per ocelli a calzamento serie C
Per ocelli ad ogiva serie O
Per ocelli standard serie A

vedi pagina 4.2.9.
vedi pagina 4.5.7.
vedi da pag. 4.20.7.
vedi pag. 4.25.5.
vedi pag. 4.35.9.

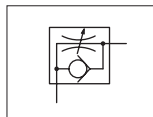
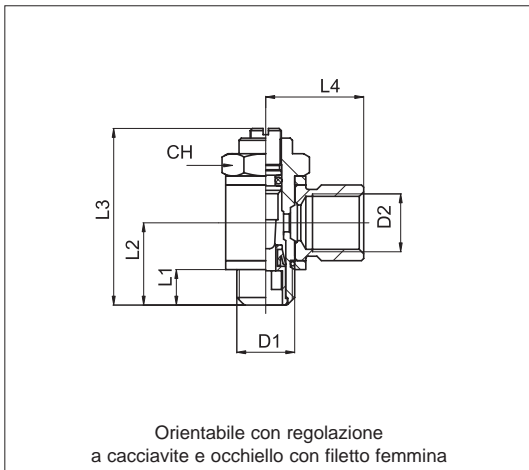

Per cilindro

Codice	Articolo	D ₁	D ₂	L ₁	L ₂	L ₃ max	L ₄	CH	gr.
024061	V17 00 M5C	M5	M5	4	11	23,5	11	8	12
024062	V17 00 18C	1/8"	1/8"	6	16	36	17	14	34
024063	V17 00 14C	1/4"	1/4"	8	19	42	22	17	62
024064	V17 00 38C	3/8"	3/8"	9	22	52	26	20	98
024065	V17 00 12C	1/2"	1/2"	10	25	61	32	26	176

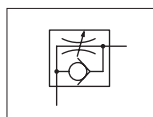
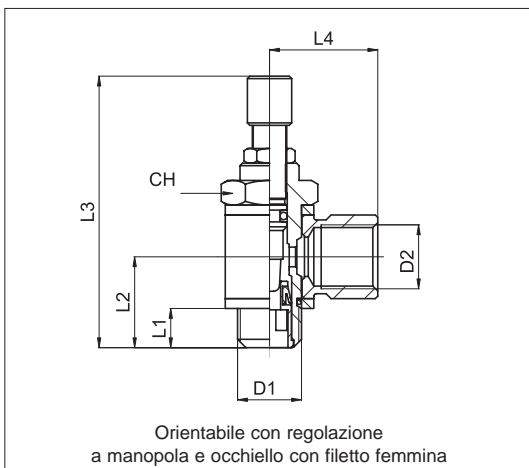

Per cilindro

Codice	Articolo	D ₁	D ₂	L ₁	L ₂	L ₃ max	L ₄	CH	gr.
024045	V40 00 M5C	M5	M5	4	11	38,5	11	8	14
024046	V40 00 18C	1/8"	1/8"	6	16	50	17	14	40
024047	V40 00 14C	1/4"	1/4"	8	19	58	22	17	68
024048	V40 00 38C	3/8"	3/8"	9	22	72	26	20	106
024049	V40 00 12C	1/2"	1/2"	10	25	81	32	26	189

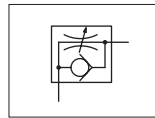
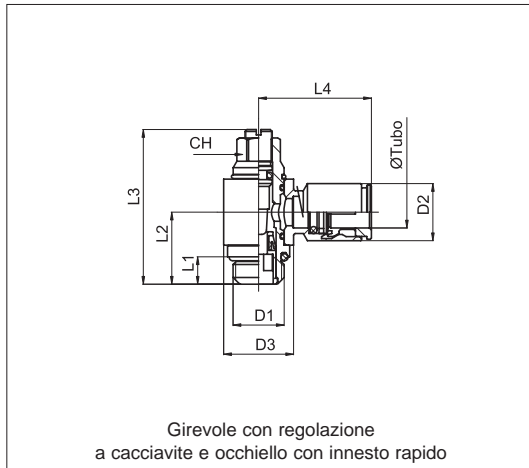

Per cilindro

Codice	Articolo	Øe Tubo	D ₁	D ₂	D ₃	L ₁	L ₂	L ₃ max	L ₄	CH	gr.
024081	V18 04 M5C	4	M5	9	10	4	11,5	25,5	18	6	12
024082	V18 04 18C	4	1/8"	9	14	5	15	32	24	9	29
024085	V18 06 18C	6	1/8"	12	14	5	15	32	26	9	27
024086	V18 06 14C	6	1/4"	12	18	6,5	18	40	24	10	49
024087	V18 08 18C	8	1/8"	14	14	5	15	32	24	9	31
024088	V18 08 14C	8	1/4"	14	18	6,5	18	40	24	10	49
020246	V18 08 38C	8	3/8"	14	22	9	22	50	26	14	89
024089	V18 10 14C	10	1/4"	16	18	6,5	18	40	30	10	53
024090	V18 10 38C	10	3/8"	16	22	9	22	50	28	14	86

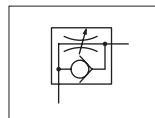
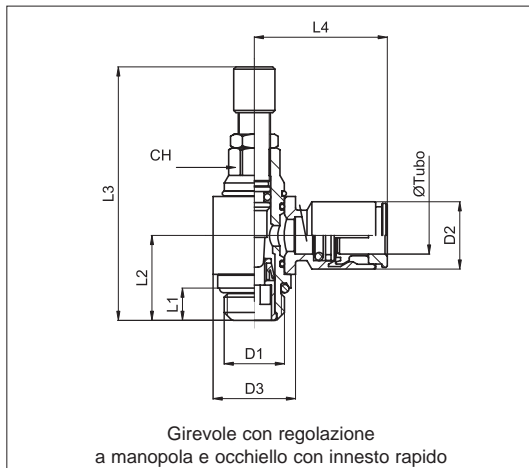

Per cilindro

Codice	Articolo	Øe Tubo	D ₁	D ₂	D ₃	L ₁	L ₂	L ₃ max	L ₄	CH	gr.
024185	V41 04 M5C	4	M5	10	10	4	11,5	39	24	6	15
024186	V41 04 18C	4	1/8"	10	14	5	15	50	24	9	37
024189	V41 06 18C	6	1/8"	13	14	5	15	50	26	9	41
024190	V41 06 14C	6	1/4"	13	18	6,5	18	58	28	10	63
024191	V41 08 18C	8	1/8"	15	14	5	15	50	28	9	45
024192	V41 08 14C	8	1/4"	15	18	6,5	18	58	28	10	62
024194	V41 08 38C	8	3/8"	14	22	9	22	50	26	14	89
024193	V41 10 14C	10	1/4"	18	18	6,5	18	58	32	10	93
024195	V41 19 38C	10	3/8"	16	22	9	22	63	28	14	105

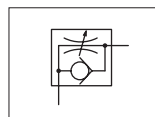
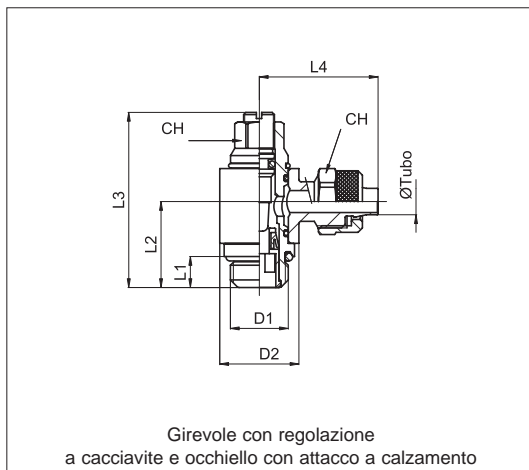

Per cilindro

Codice	Articolo	Ø Tubo	D ₁	D ₂	L ₁	L ₂	L ₃ max	L ₄	CH ₁	CH ₂	gr.
024141	V20 04 M5C	4-2,5	M5	10	4	11,5	28	15,5	6	7	12
024144	V20 06 M5C	6-4	M5	10	4	11,5	28	19	6	9	12
024145	V20 06 18C	6-4	1/8"	14	5	15	36	25	9	12	40
024146	V20 06 14C	6-4	1/4"	18	6,5	18	42	26,5	10	12	53
024147	V20 08 18C	8-6	1/8"	14	5	15	36	25	9	14	42
024148	V20 08 14C	8-6	1/4"	18	6,5	18	42	27,5	10	14	68
024160	V20 08 38C	8-6	3/8"	22	9	22	50	29,5	14	12	90
024149	V20 10 14C	10-8	1/4"	18	6,5	18	42	28,5	10	16	57
024149	V20 10 38C	10-8	3/8"	22	9	22	50	30,5	14	16	92

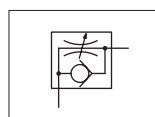
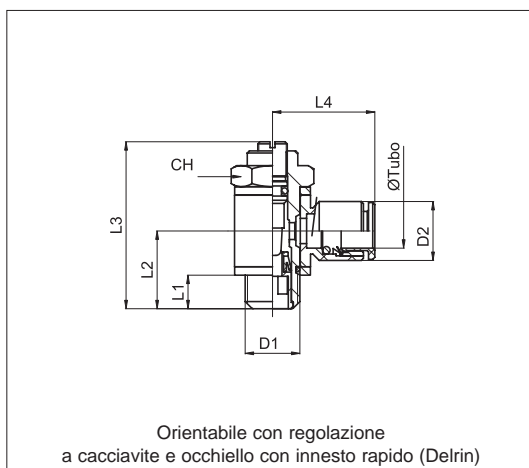

Per cilindro

Codice	Articolo	Øe Tubo	D ₁	D ₂	L ₁	L ₂	L ₃ max	L ₄	CH	gr.
024100	V39 04 M5C	4	M5	9,7	6	11	23,5	17	8	7
024101	V39 04 18C	4	1/8"	9,7	7	16	36	18,5	14	20
024109	V39 06 M5C	6	M5	12	6	11	23,5	20,5	8	8
024103	V39 06 18C	6	1/8"	12	7	16	36	22	14	22
024104	V39 06 14C	6	1/4"	12	9	19	42	23,5	17	38
024105	V39 08 18C	8	1/8"	14	7	16	36	22,5	14	22
024106	V39 08 14C	8	1/4"	14	9	19	42	24	17	39
024110	V39 08 38C	8	3/8"	14	10	22	52	26	20	67
024107	V39 10 14C	10	1/4"	16,5	9	19	42	26	17	39
024108	V39 10 38C	10	3/8"	16,5	10	22	52	28	20	68

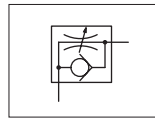
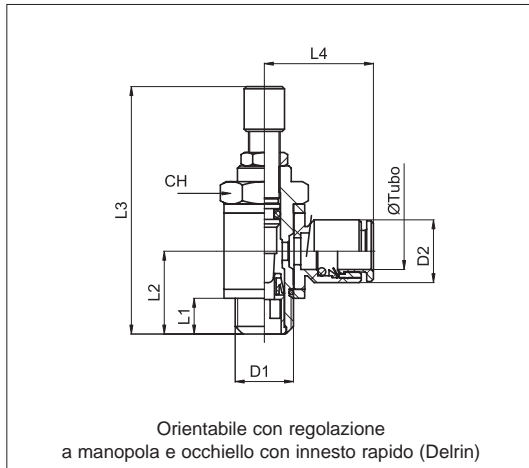

Per cilindro

Codice	Articolo	Øe Tubo	D ₁	D ₂	L ₁	L ₂	L ₃ max	L ₄	CH	gr.
024311	V37 04 M5C	4	M5	9,7	4	11	38,5	17	8	9
024312	V37 04 18C	4	1/8"	9,7	6	16	50	18,5	14	23
024313	V37 06 M5C	6	M5	12	4	11	38,5	20,5	8	10
024314	V37 06 18C	6	1/8"	12	6	16	50	22	14	25
024315	V37 06 14C	6	1/4"	12	8	19	58	23,5	17	41
024316	V37 08 18C	8	1/8"	14	6	16	50	22,5	14	25
024317	V37 08 14C	8	1/4"	14	8	19	58	24	17	42
024318	V37 08 38C	8	3/8"	14	9	22	72	26	20	70
024319	V37 10 14C	10	1/4"	16,5	8	19	58	26	17	42
024320	V37 10 38C	10	3/8"	16,5	9	22	72	28	20	71

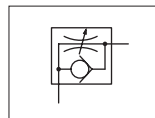
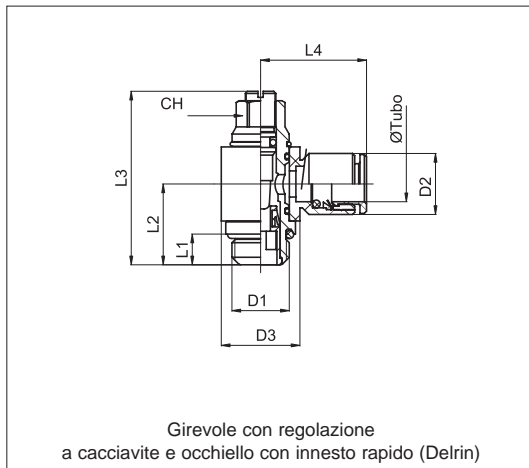

Per cilindro

Codice	Articolo	Øe Tubo	D ₁	D ₂	D ₃	L ₁	L ₂	L ₃ max	L ₄	CH	gr.
024201	V38 04 M5C	4	M5	9,7	9,7	4	11,5	28	17	6	8
024202	V38 04 18C	4	1/8"	9,7	15	5	15	36	18,5	9	17
024208	V38 06 M5C	6	M5	12	9,7	4	11,5	28	20,5	6	9
024203	V38 06 18C	6	1/8"	12	15	5	15	36	22	9	18
024204	V38 06 14C	6	1/4"	12	18	6,5	18	42	23,5	10	31
024205	V38 08 18C	8	1/8"	14	15	5	15	36	22,5	9	20
024206	V38 08 14C	8	1/4"	14	18	6,5	18	42	24	10	32
024210	V38 08 38C	8	3/8"	14	22	9	22	50	26	14	59
024207	V38 10 14C	10	1/4"	16	18	6,5	18	42	26,5	10	33
024209	V38 10 38C	10	3/8"	16	22	9	22	50	28	14	60

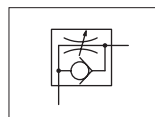
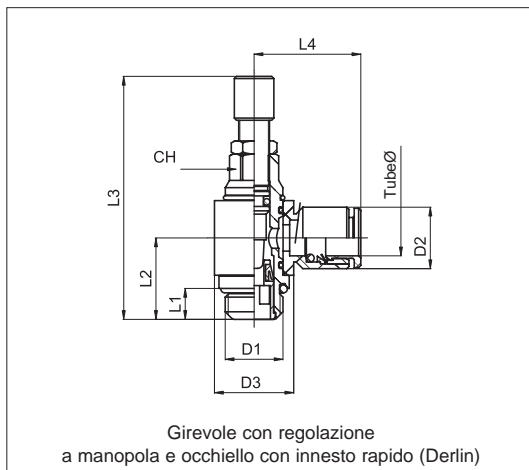

Per cilindro

Codice	Articolo	Øe Tubo	D ₁	D ₂	D ₃	L ₁	L ₂	L ₃ max	L ₄	CH	gr.
024331	V36 04 M5C	4	M5	9,7	9,7	4	11,5	25,5	17	6	10
024332	V36 04 18C	4	1/8"	9,7	15	5	15	32	18,5	9	20
024333	V36 06 M5C	6	M5	12	9,7	4	11,5	25,5	20,5	6	11
024334	V36 06 18C	6	1/8"	12	15	5	15	32	22	9	21
024335	V36 06 14C	6	1/4"	12	18	6,5	18	40	23,5	10	34
024336	V36 08 18C	8	1/8"	14	15	5	15	32	22,5	9	23
024337	V36 08 14C	8	1/4"	14	18	6,5	18	40	24	10	35
024340	V36 08 38C	8	3/8"	14	22	9	22	50	26	14	59
024338	V36 10 14C	10	1/4"	16	18	6,5	18	40	26	10	36
024339	V36 10 38C	10	3/8"	16	18	9	22	50	28	14	60

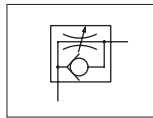
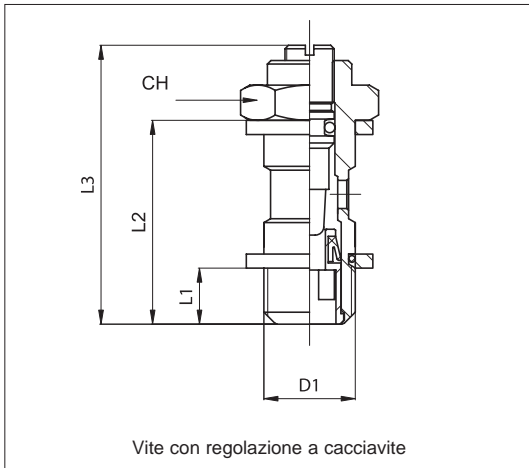

Per valvola

Codice	Articolo	D ₁	L ₁	L ₂	L ₃ max	CH	gr.
024031	V15 00 M5V	M5	4	16	23,5	8	5
024032	V15 00 18V	1/8"	6	25	36	14	16
024033	V15 00 14V	1/4"	8	29	42	17	32
024034	V15 00 38V	3/8"	9	33	52	20	59

Per occhielli innesto rapido serie R
Per occhielli innesto rapido serie RT
Per occhielli a calzamento serie C
Per occhielli ad ogiva serie O
Per occhielli standard serie A

vedi pagina 4.2.9.
vedi pagina 4.5.7.
vedi da pag. 4.20.7.
vedi pag. 4.25.5.
vedi pag. 4.35.9.

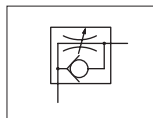
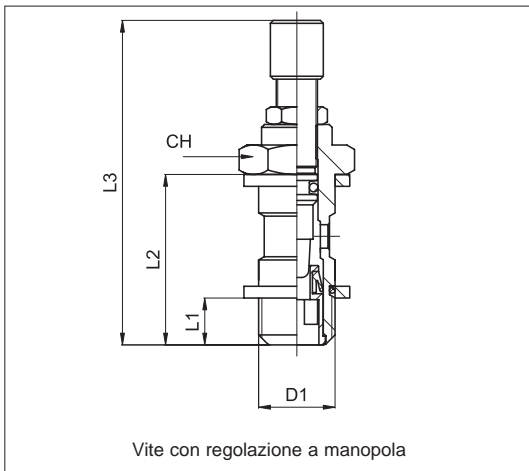

Per valvola

Codice	Articolo	D ₁	L ₁	L ₂	L ₃ max	CH	gr.
024341	V14 00 M5V	M5	4	16	38,5	8	7
024342	V14 00 18V	1/8"	6	25	50	14	22
024343	V14 00 14V	1/4"	8	29	58	17	38
024344	V14 00 38V	3/8"	9	33	72	20	67

Per occhielli innesto rapido serie R
Per occhielli innesto rapido serie RT
Per occhielli a calzamento serie C
Per occhielli ad ogiva serie O
Per occhielli standard serie A

vedi pagina 4.2.9.
vedi pagina 4.5.7.
vedi da pag. 4.20.7.
vedi pag. 4.25.5.
vedi pag. 4.35.9.

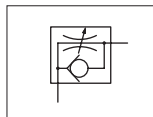
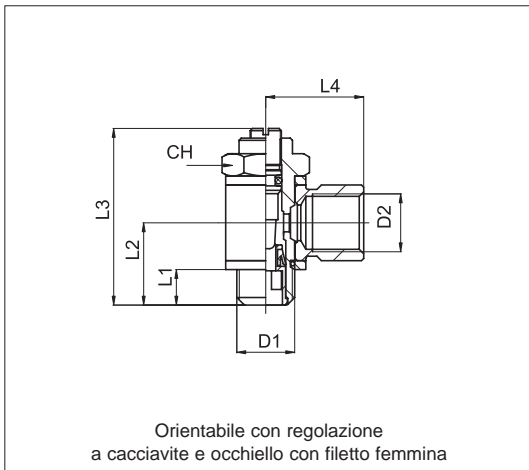

Per valvola

Codice	Articolo	D ₁	D ₂	L ₁	L ₂	L ₃ max	L ₄	CH	gr.
024067	V17 00 M5V	M5	M5	4	11	23,5	11	8	12
024068	V17 00 18V	1/8"	1/8"	6	16	36	17	14	34
024069	V17 00 14V	1/4"	1/4"	8	19	42	22	17	62
024070	V17 00 38V	3/8"	3/8"	9	22	52	26	20	98

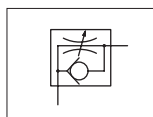
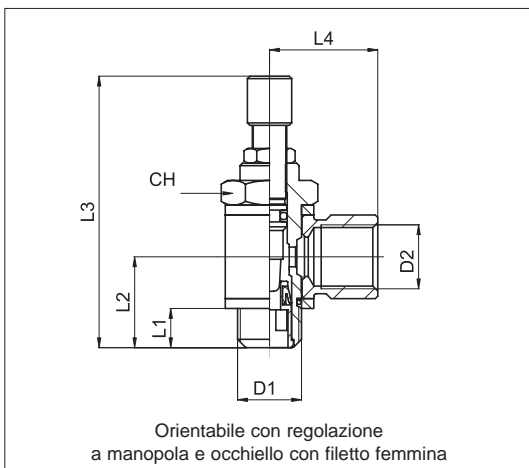

Per valvola

Codice	Articolo	D ₁	D ₂	L ₁	L ₂	L ₃ max	L ₄	CH	gr.
024351	V40 00 M5V	M5	M5	4	11	38,5	11	8	14
024352	V40 00 18V	1/8"	1/8"	6	16	50	17	14	40
024353	V40 00 14V	1/4"	1/4"	8	19	58	22	17	68
024354	V40 00 38V	3/8"	3/8"	9	22	72	26	20	106

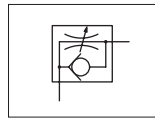
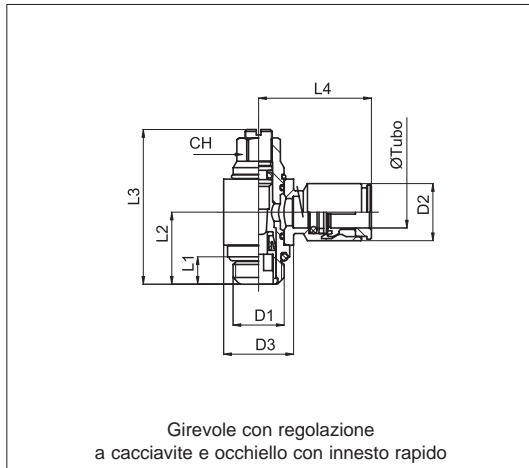

Per valvola

Codice	Articolo	Øe Tubo	D ₁	D ₂	D ₃	L ₁	L ₂	L ₃ max	L ₄	CH	gr.
024091	V18 04 M5V	4	M5	10	10	4	11,5	28	24	6	13
024092	V18 04 18V	4	1/8"	10	14	5	15	36	24	9	31
024095	V18 06 18V	6	1/8"	13	14	5	15	36	26	9	35
024096	V18 06 14V	6	1/4"	13	18	6,5	18	42	28	10	57
024097	V18 08 18V	8	1/8"	15	14	5	15	36	28	9	39
024098	V18 08 14V	8	1/4"	15	18	6,5	18	42	28	10	56
024120	V18 08 38V	8	3/8"	14	22	9	22	50	26	14	89
024099	V18 10 14V	10	1/4"	18	18	6,5	18	42	32	10	87
024140	V18 10 38V	10	3/8"	16	22	9	22	50	28	14	86

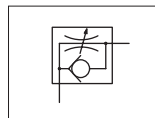
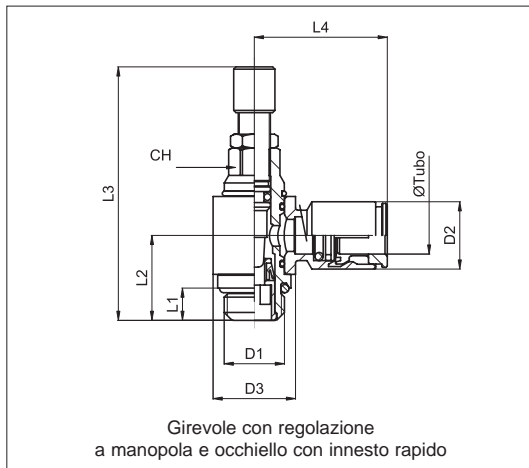

Per valvola

Codice	Articolo	Øe Tubo	D ₁	D ₂	D ₃	L ₁	L ₂	L ₃ max	L ₄	CH	gr.
024361	V41 04 M5V	4	M5	10	10	4	11,5	39	24	6	15
024362	V41 04 18V	4	1/8"	10	14	5	15	50	24	9	37
024365	V41 06 18V	6	1/8"	13	14	5	15	50	26	9	41
024366	V41 06 14V	6	1/4"	13	18	6,5	18	58	28	10	63
024367	V41 08 18V	8	1/8"	15	14	5	15	50	28	9	45
024368	V41 08 14V	8	1/4"	15	18	6,5	18	58	28	10	62
024370	V41 08 38V	8	3/8"	14	22	9	22	63	26	14	99
024369	V41 10 14V	10	1/4"	18	18	6,5	18	58	32	10	93
024378	V41 10 38V	10	3/8"	16	22	9	22	63	28	14	105

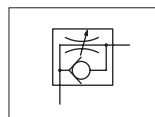
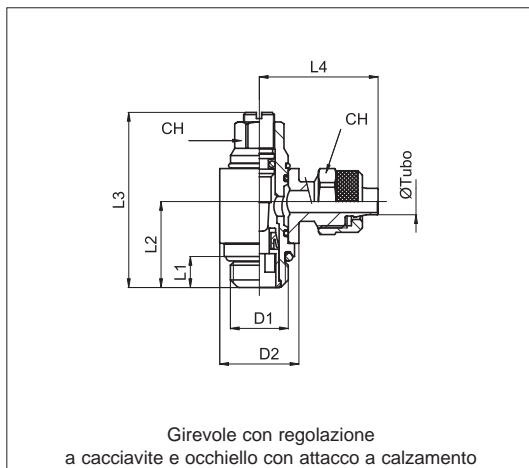

Per valvola

Codice	Articolo	Øe Tubo	D ₁	D ₂	L ₁	L ₂	L ₃ max	L ₄	CH ₁	CH ₂	gr.
024151	V20 04 M5V	4-2,5	M5	10	4	11,5	28	15,5	6	7	12
024155	V20 06 18V	6-4	1/8"	14	5	15	36	25	9	12	40
024156	V20 06 14V	6-4	1/4"	18	6,5	18	42	26,5	10	12	53
024157	V20 08 18V	8-6	1/8"	14	5	15	36	25	9	14	42
024158	V20 08 14V	8-6	1/4"	18	6,5	18	42	27,5	10	14	68
024172	V20 08 38V	8-6	3/8"	22	9	22	50	29,5	14	14	90
024159	V20 10 14V	10-8	1/4"	18	6,5	18	42	28,5	10	16	57
024174	V20 10 38V	10-8	3/8"	22	9	22	50	30,5	14	16	92

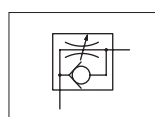
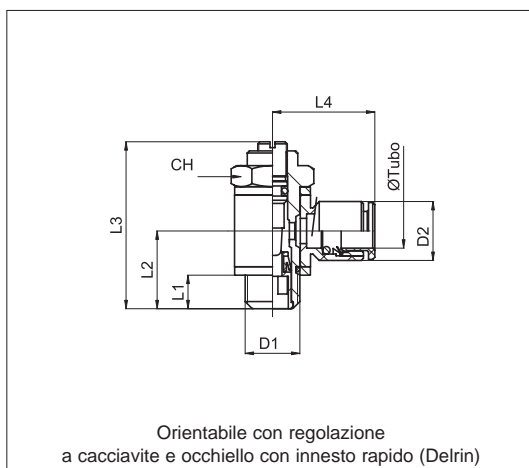

Per valvola

Codice	Articolo	Øe Tubo	D ₁	D ₂	L ₁	L ₂	L ₃ max	L ₄	CH	gr.
024119	V39 04 M5V	4	M5	9,7	6	11	23,5	17	8	7
024111	V39 04 18V	4	1/8"	9,7	7	16	36	18,5	14	20
024230	V39 06 M5V	6	M5	12	6	11	23,5	20,5	8	8
024113	V39 06 18V	6	1/8"	12	7	16	36	22	14	22
024114	V39 06 14V	6	1/4"	12	9	19	42	23,5	17	38
024115	V39 08 18V	8	1/8"	14	7	16	36	22,5	14	22
024116	V39 08 14V	8	1/4"	14	9	19	42	24	17	39
024231	V39 08 38V	8	3/8"	14	10	22	52	26	20	67
024117	V39 10 14V	10	1/4"	16,5	9	19	42	26	17	39
024118	V39 10 38V	10	3/8"	16,5	10	22	52	28	20	68

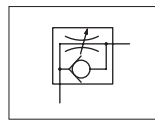
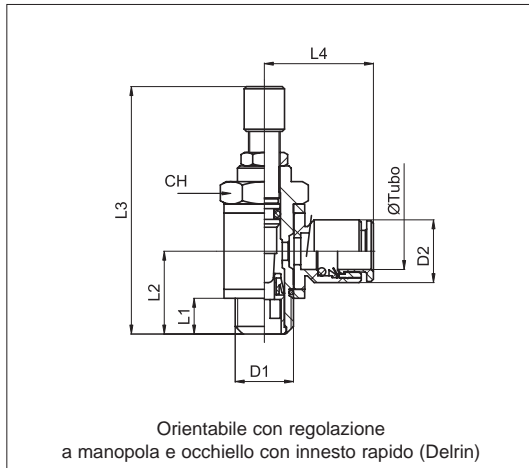

Per valvola

Codice	Articolo	Øe Tubo	D1	D2	L1	L2	L3 max	L4	CH	gr.
024381	V37 04 M5V	4	M5	9,7	4	11	38,5	17	8	9
024382	V37 04 18V	4	1/8"	9,7	6	16	50	18,5	14	23
024383	V37 06 M5V	6	M5	12	4	11	38,5	20,5	8	10
024384	V37 06 18V	6	1/8"	12	6	16	50	22	14	25
024385	V37 06 14V	6	1/4"	12	8	19	58	23,5	17	41
024386	V37 08 18V	8	1/8"	14	6	16	50	22,5	14	25
024387	V37 08 14V	8	1/4"	14	8	19	58	24	17	42
024388	V37 08 38V	8	3/8"	14	9	22	72	26	20	70
024389	V37 10 14V	10	1/4"	16,5	8	19	58	26	17	42
024390	V37 10 38V	10	3/8"	16,5	9	22	72	28	20	71

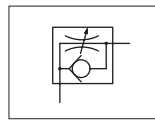
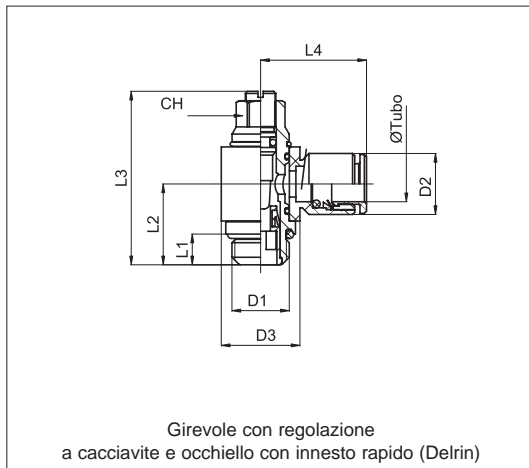

Per valvola

Codice	Articolo	Øe Tubo	D1	D2	D3	L1	L2	L3 max	L4	CH	gr.
024211	V38 04 M5V	4	M5	9,7	9,7	4	11,5	28	17	6	8
024212	V38 04 18V	4	1/8"	9,7	15	5	15	36	18,5	9	17
024218	V38 06 M5V	6	M5	12	9,7	4	11,5	28	20,5	6	9
024213	V38 06 18V	6	1/8"	12	15	5	15	36	22	9	18
024214	V38 06 14V	6	1/4"	12	18	6,5	18	42	23,5	10	31
024215	V38 08 18V	8	1/8"	14	15	5	15	36	22,5	9	20
024216	V38 08 14V	8	1/4"	14	18	6,5	18	42	24	10	32
024219	V38 08 38V	8	3/8"	14	22	9	22	50	26	14	59
024217	V38 10 14V	10	1/4"	16	18	6,5	18	42	26,5	10	33
024220	V38 10 38V	10	3/8"	16	22	9	22	50	28	14	60

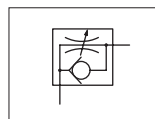
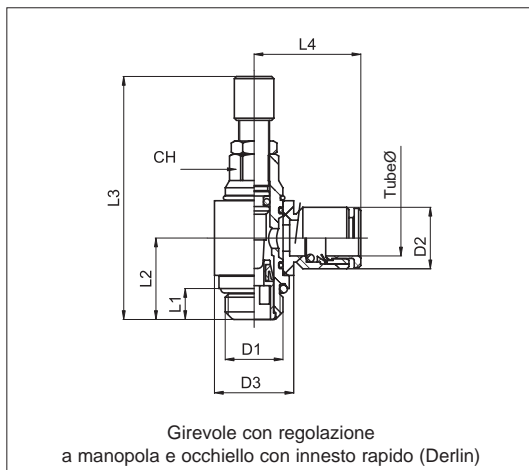

Per valvola

Codice	Articolo	Øe Tubo	D1	D2	D3	L1	L2	L3 max	L4	CH	gr.
024401	V36 04 M5V	4	M5	9,7	9,7	4	11,5	39	17	6	10
024402	V36 04 18V	4	1/8"	9,7	15	5	15	50	18,5	9	20
024403	V36 06 M5V	6	M5	12	9,7	4	11,5	39	20,5	6	11
024404	V36 06 18V	6	1/8"	12	15	5	15	50	22	9	21
024405	V36 06 14V	6	1/4"	12	18	6,5	18	58	23,5	10	34
024406	V36 08 18V	8	1/8"	14	15	5	15	50	22,5	9	23
024407	V36 08 14V	8	1/4"	14	18	6,5	18	58	24	10	35
024409	V36 08 38V	8	3/8"	14	22	9	22	50	26	14	59
024408	V36 10 14V	10	1/4"	16	18	6,5	18	58	26	10	36
024410	V36 10 38V	10	3/8"	16	22	9	22	50	28	14	60

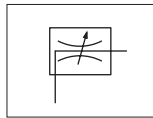
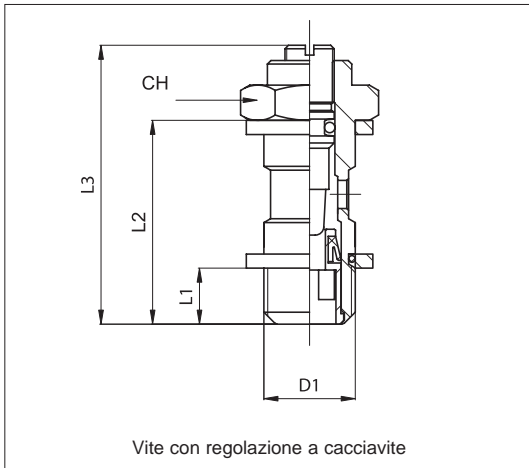

Bidirezionali

Codice	Articolo	D ₁	L ₁	L ₂	L ₃ max	CH	gr.
024001	V15 00 M5B	M5	4	16	23,5	8	5
024002	V15 00 18B	1/8"	6	25	36	14	16
024003	V15 00 14B	1/4"	8	29	42	17	32
024004	V15 00 38B	3/8"	9	33	52	20	59
024005	V15 00 12B	1/2"	10	39	61	26	108

Per occhielli innesto rapido serie R
Per occhielli innesto rapido serie RT
Per occhielli a calzamento serie C
Per occhielli ad ogiva serie O
Per occhielli standard serie A

vedi pagina 4.2.9.
vedi pagina 4.5.7.
vedi da pag. 4.20.7.
vedi pag. 4.25.5.
vedi pag. 4.35.9.

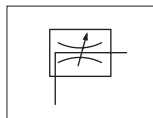
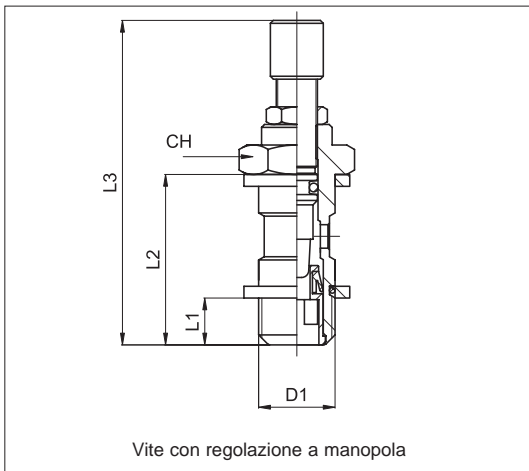

Bidirezionali

Codice	Articolo	D ₁	L ₁	L ₂	L ₃ max	CH	gr.
024411	V14 00 M5B	M5	4	16	38,5	8	7
024412	V14 00 18B	1/8"	6	25	50	14	22
024413	V14 00 14B	1/4"	8	29	58	17	38
024414	V14 00 38B	3/8"	9	33	72	20	67
024415	V14 00 12B	1/2"	10	39	81	26	121

Per occhielli innesto rapido serie R
Per occhielli innesto rapido serie RT
Per occhielli a calzamento serie C
Per occhielli ad ogiva serie O
Per occhielli standard serie A

vedi pagina 4.2.9.
vedi pagina 4.5.7.
vedi da pag. 4.20.7.
vedi pag. 4.25.5.
vedi pag. 4.35.9.

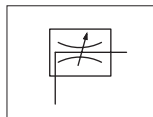
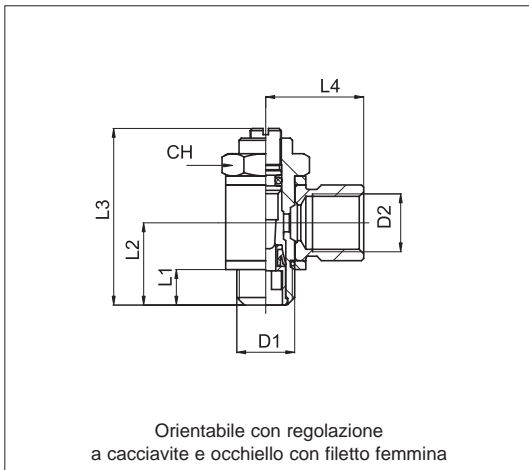

Bidirezionali

Codice	Articolo	D ₁	D ₂	L ₁	L ₂	L ₃ max	L ₄	CH	gr.
024073	V17 00 M5B	M5	M5	4	11	23,5	11	8	12
024074	V17 00 18B	1/8"	1/8"	6	16	36	17	14	34
024075	V17 00 14B	1/4"	1/4"	8	19	42	22	17	62
024076	V17 00 38B	3/8"	3/8"	9	22	52	26	20	98
024077	V17 00 12B	1/2"	1/2"	10	25	61	32	26	176

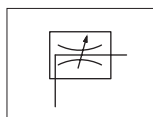
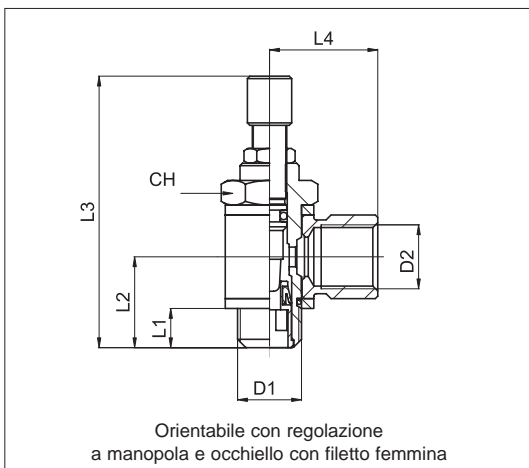

Bidirezionali

Codice	Articolo	D ₁	D ₂	L ₁	L ₂	L ₃ max	L ₄	CH	gr.
024421	V40 00 M5B	M5	M5	4	11	38,5	11	8	14
024422	V40 00 18B	1/8"	1/8"	6	16	50	17	14	40
024423	V40 00 14B	1/4"	1/4"	8	19	58	22	17	68
024424	V40 00 38B	3/8"	3/8"	9	22	72	26	20	106
024425	V40 00 12B	1/2"	1/2"	10	25	81	32	26	189

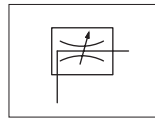
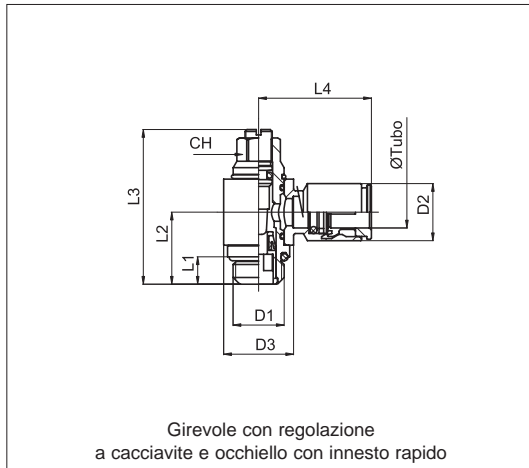

Bidirezionali

Codice	Articolo	Øe Tubo	D ₁	D ₂	D ₃	L ₁	L ₂	L ₃ max	L ₄	CH	gr.
024131	V18 04 M5B	4	M5	10	10	4	11,5	28	24	6	13
024132	V18 04 18B	4	1/8"	10	14	5	15	36	24	9	31
024135	V18 06 18B	6	1/8"	13	14	5	15	36	26	9	35
024136	V18 06 14B	6	1/4"	13	18	6,5	18	42	28	10	57
024137	V18 08 18B	8	1/8"	15	14	5	15	36	28	9	39
024138	V18 08 14B	8	1/4"	15	18	6,5	18	42	28	10	56
024175	V18 08 38B	8	3/8"	14	22	9	22	50	26	14	89
024139	V18 10 14B	10	1/4"	18	18	6,5	18	42	32	10	87
024176	V18 10 38B	10	3/8"	16	22	9	22	50	28	14	86

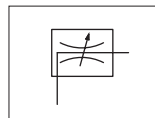
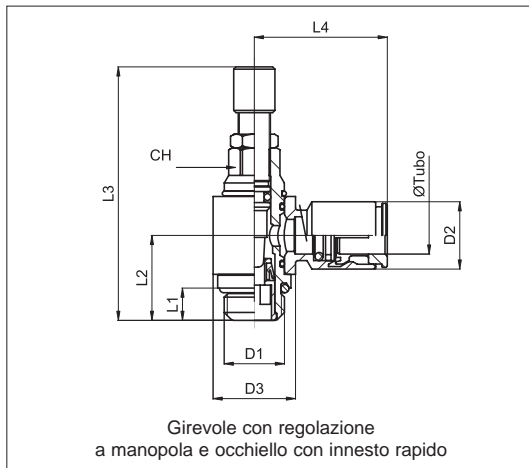

Bidirezionali

Codice	Articolo	Øe Tubo	D ₁	D ₂	D ₃	L ₁	L ₂	L ₃ max	L ₄	CH	gr.
024431	V41 04 M5B	4	M5	10	10	4	11,5	39	24	6	15
024432	V41 04 18B	4	1/8"	10	14	5	15	50	24	9	37
024435	V41 06 18B	6	1/8"	13	14	5	15	50	26	9	41
024436	V41 06 14B	6	1/4"	13	18	6,5	18	58	28	10	63
024437	V41 08 18B	8	1/8"	15	14	5	15	50	28	9	45
024438	V41 08 14B	8	1/4"	15	18	6,5	18	58	28	10	62
024440	V41 08 38B	8	3/8"	14	22	9	22	63	26	14	99
024439	V41 10 14B	10	1/4"	18	18	6,5	18	58	32	10	93
024450	V41 10 38B	10	3/8"	16	22	9	22	63	28	14	105

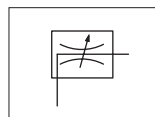
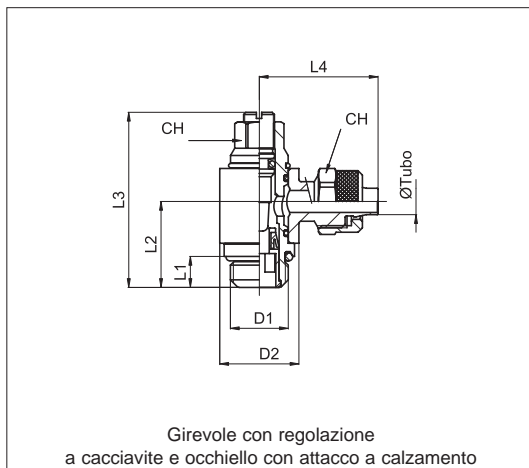

Bidirezionali

Code	Item	Tube Ø	D ₁	D ₂	L ₁	L ₂	L ₃ max	L ₄	CH ₁	CH ₂	gr.
024161	V20 04 M5B	4-2,5	M5	10	4	11,5	28	15,5	6	7	12
024164	V20 06 M5B	6-4	M5	10	4	11,5	28	19	6	9	12
024165	V20 06 18B	6-4	1/8"	14	5	15	36	25	9	12	40
024166	V20 06 14B	6-4	1/4"	18	6,5	18	42	26,5	10	12	53
024167	V20 08 18B	8-6	1/8"	14	5	15	36	25	9	14	42
024168	V20 08 14B	8-6	1/4"	18	6,5	18	42	27,5	10	14	68
024177	V20 08 38B	8-6	3/8"	22	9	22	50	29,5	14	14	90
024169	V20 10 14B	10-8	1/4"	18	6,5	18	42	28,5	10	16	57
024178	V20 10 38B	10-8	3/8"	22	9	22	50	30,5	14	16	92

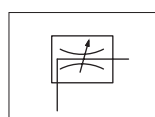
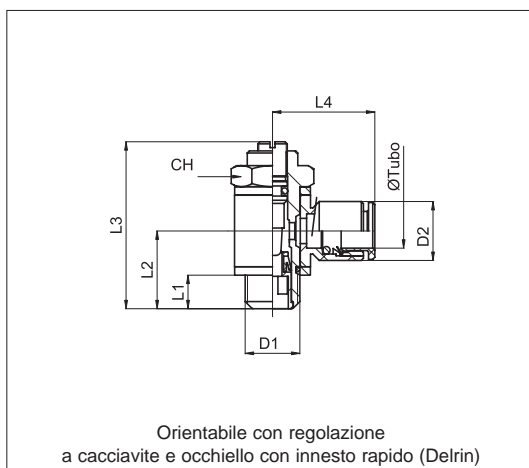

Bidirezionali

Codice	Articolo	Øe Tubo	D ₁	D ₂	L ₁	L ₂	L ₃ max	L ₄	CH	gr.
024120	V39 04 M5B	4	M5	9,7	6	11	23,5	17	8	7
024121	V39 04 18B	4	1/8"	9,7	7	16	36	18,5	14	20
024129	V39 06 M5B	6	M5	12	6	11	23,5	20,5	8	8
024123	V39 06 18B	6	1/8"	12	7	16	36	22	14	22
024124	V39 06 14B	6	1/4"	12	9	19	42	23,5	17	38
024125	V39 08 18B	8	1/8"	14	7	16	36	22,5	14	22
024126	V39 08 14B	8	1/4"	14	9	19	42	24	17	39
024130	V39 08 38B	8	3/8"	14	10	22	52	26	20	67
024127	V39 10 14B	10	1/4"	16,5	9	19	42	26	17	39
024128	V39 10 38B	10	3/8"	16,5	10	22	52	28	20	68

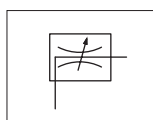
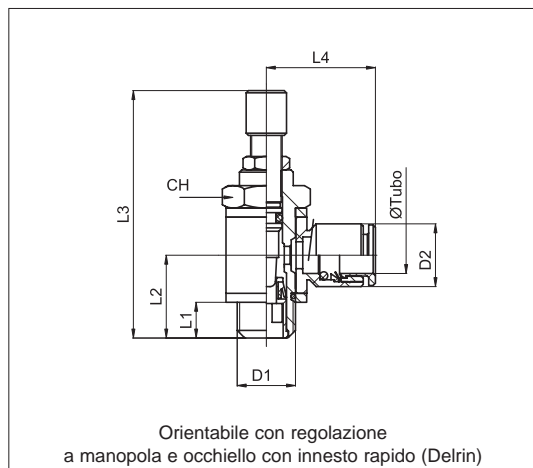

Bidirezionali

Codice	Articolo	Øe Tubo	D ₁	D ₂	L ₁	L ₂	L ₃ max	L ₄	CH	gr.
024451	V37 04 M5B	4	M5	9,7	4	11	38,5	17	8	9
024452	V37 04 18B	4	1/8"	9,7	6	16	50	18,5	14	23
024453	V37 06 M5B	6	M5	12	4	11	38,5	20,5	8	10
024454	V37 06 18B	6	1/8"	12	6	16	50	22	14	25
024455	V37 06 14B	6	1/4"	12	8	19	58	23,5	17	41
024456	V37 08 18B	8	1/8"	14	6	16	50	22,5	14	25
024457	V37 08 14B	8	1/4"	14	8	19	58	24	17	42
024458	V37 08 38B	8	3/8"	14	9	22	72	26	20	70
024459	V37 10 14B	10	1/4"	16,5	8	19	58	26	17	42
024460	V37 10 38B	10	3/8"	16,5	9	22	72	28	20	71

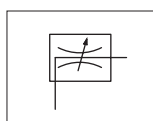
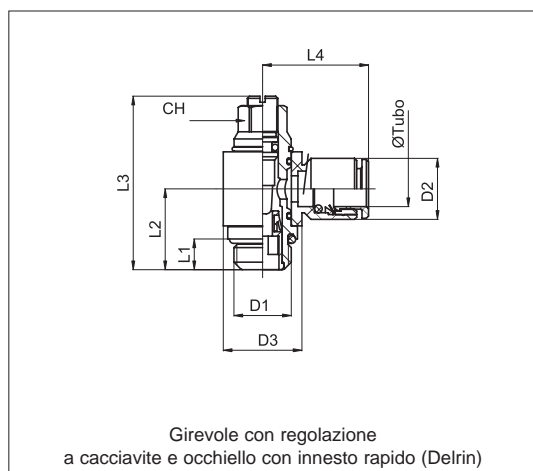

Bidirezionali

Codice	Articolo	Øe Tubo	D ₁	D ₂	D ₃	L ₁	L ₂	L ₃ max	L ₄	CH	gr.
024221	V38 04 M5B	4	M5	9,7	9,7	4	11,5	28	17	6	8
024222	V38 04 18B	4	1/8"	9,7	15	5	15	36	18,5	9	17
024227	V38 06 M5B	6	M5	12	9,7	4	11,5	28	20,5	6	9
024223	V38 06 18B	6	1/8"	12	15	5	15	36	22	9	18
024224	V38 06 14B	6	1/4"	12	18	6,5	18	42	23,5	10	31
024225	V38 08 18B	8	1/8"	14	15	5	15	36	22,5	9	20
024226	V38 08 14B	8	1/4"	14	18	6,5	18	42	24	10	32
024229	V38 08 38B	8	3/8"	14	22	9	22	50	26	14	59
024228	V38 10 14B	10	1/4"	16	18	6,5	18	42	26,5	10	33
024254	V38 10 38B	10	3/8"	16	22	9	22	50	28	14	60

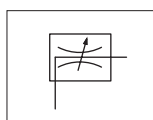
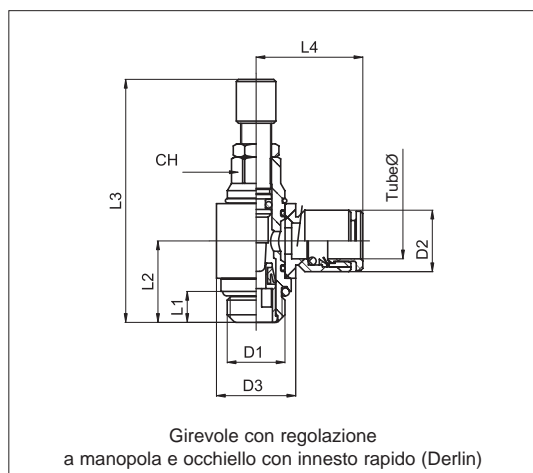

Bidirezionali

Codice	Articolo	Øe Tubo	D ₁	D ₂	D ₃	L ₁	L ₂	L ₃ max	L ₄	CH	gr.
024481	V36 04 M5B	4	M5	9,7	9,7	4	11,5	39	17	6	10
024482	V36 04 18B	4	1/8"	9,7	15	5	15	50	18,5	9	20
024483	V36 06 M5B	6	M5	12	9,7	4	11,5	39	20,5	6	11
024484	V36 06 18B	6	1/8"	12	15	5	15	50	22	9	21
024485	V36 06 14B	6	1/4"	12	18	6,5	18	58	23,5	10	34
024486	V36 08 18B	8	1/8"	14	15	5	15	50	22,5	9	23
024487	V36 08 14B	8	1/4"	14	18	6,5	18	58	24	10	35
024487	V36 08 38B	8	3/8"	14	22	9	22	50	26	14	59
024488	V36 10 14B	10	1/4"	16	18	6,5	18	58	26	10	36
024488	V36 10 38B	10	3/8"	16	22	9	22	50	28	14	60

Tipo: V18 - V41

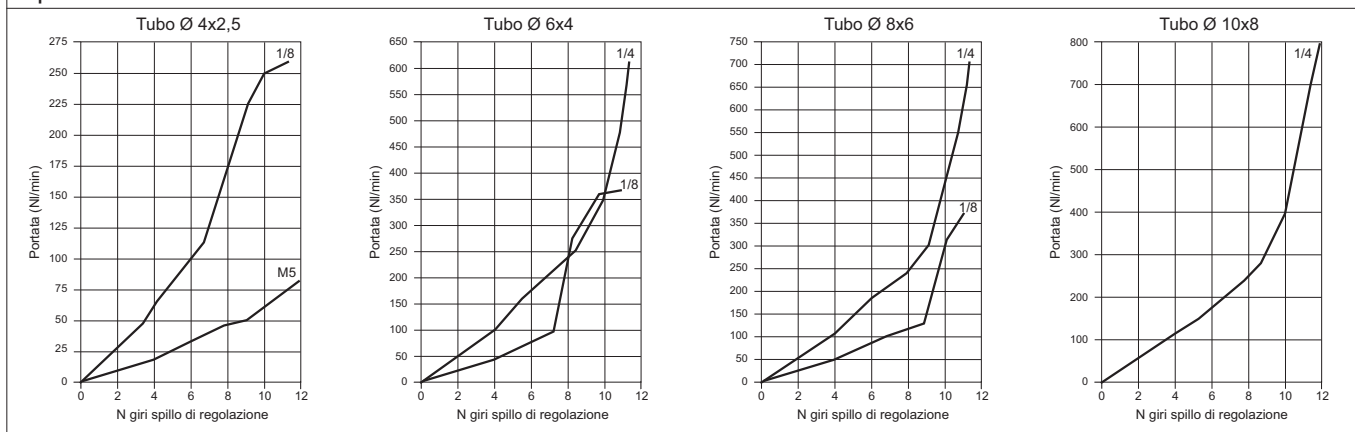

Tipo: V20

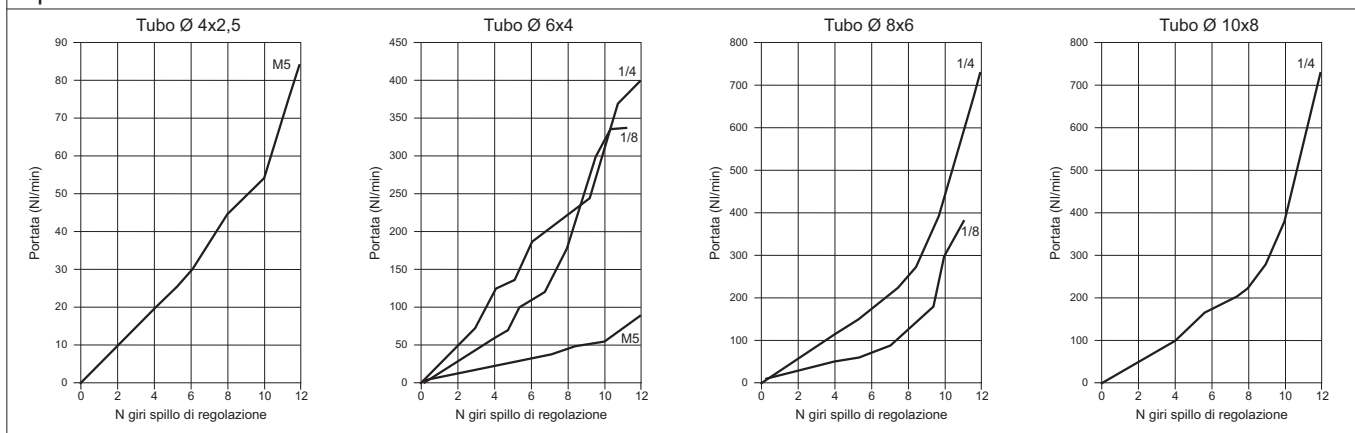

Tipo: V37 - V39

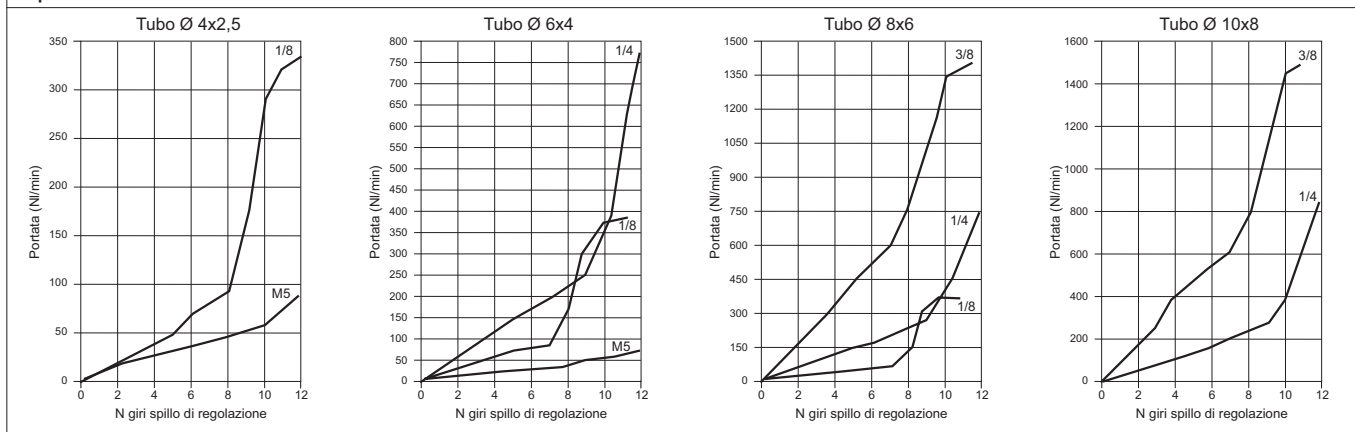

Tipo: V36 - V38

