

Regolatori di portata INOX

In linea, per cilindri



Versione	Tipo
Unidirezionale in linea filetto FF	VX52
Bidirezionale in linea filetto FF	VX53
Vite di regolazione per cilindro	VX15
Per cilindro girevole con innesto rapido	VX18



Serie di regolatori di portata in acciaio INOX disponibili nelle versioni per applicazione in linea e direttamente sulle connessioni dei cilindri per il controllo della velocità della traslazione.

I regolatori in linea sono fornibili nelle versioni con regolazione in un unico senso (unidirezionali) oppure in entrambe (bidirezionali).

I regolatori per cilindro possono essere unidirezionali con regolazione in uscita dal cilindro (C) oppure con regolazione in entrata al cilindro (V), nonché in entrambi i lati (B).

Per gli articoli standard, codici e dimensioni vedi tabelle pag. 5.185.2.

Per l'accoppiamento delle vite di regolazione tipo VX15 con l'occhiello semplice INOX, vedi occhiello tipo RX35 a pag. 5.150.5

Portate

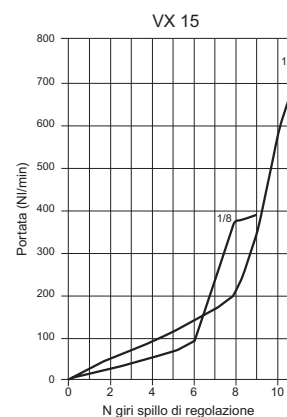
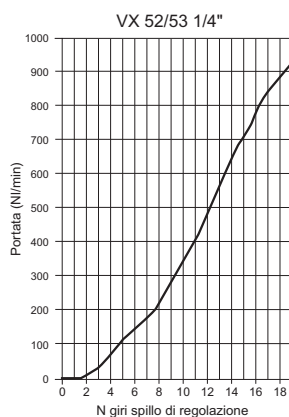
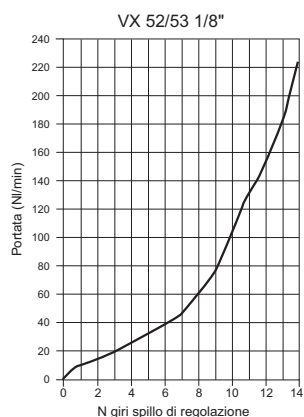

Caratteristiche tecniche

Tipo	VX52 - VX53	VX15	VX18
Fluido	Aria compressa filtrata con o senza lubrificazione		
Pressione	0,5 ÷ 10 bar	0 ÷ 10 bar	
Temperatura	-20 °C ÷ 150 °C		0 °C ÷ 150 °C
Filettature	UNI - ISO 228		
Materiali	Corpo: Acciaio INOX AISI 316 L Spillo e regolatore: Acciaio INOX AISI 316 L Pomolo: Acciaio INOX AISI 316 L Dado: Acciaio INOX AISI 316 L Guarnizioni: FPM	Corpo: Acciaio INOX AISI 316 L Spillo: Acciaio INOX AISI 316 L Bussola: Acciaio INOX AISI 316 L Guarnizioni: FPM Rondella: PTFE	Corpo: Acciaio INOX AISI 316 L Spillo: Acciaio INOX AISI 316 L Bussola: Acciaio INOX AISI 316 L Guarnizioni: FPM Anello: Acciaio INOX AISI 316 L

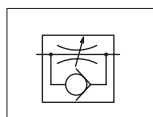
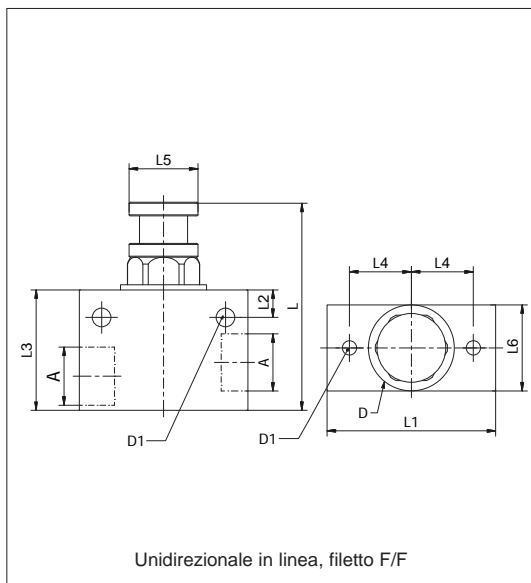

Codice	Articolo	A	L		L ₁	L ₂	L ₃	L ₄	L ₅	L ₅	D Ø	D ₁ Ø	Weight gr
			min	max									
030155	VX52 18 18	1/8"	49	54	40	8	30	15	20	20	5,4	M5	168
030156	VX52 14 14	1/4"	49	54	40	8	30	15	20	20	5,4	M5	178
030146	VX52 38 38	3/8"	57	66	49	8	35	18	20	25	5,4	M5	305
030147	VX52 12 12	1/2"	57	66	49	8	35	18	20	25	5,4	M5	310

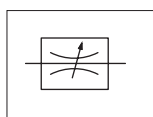
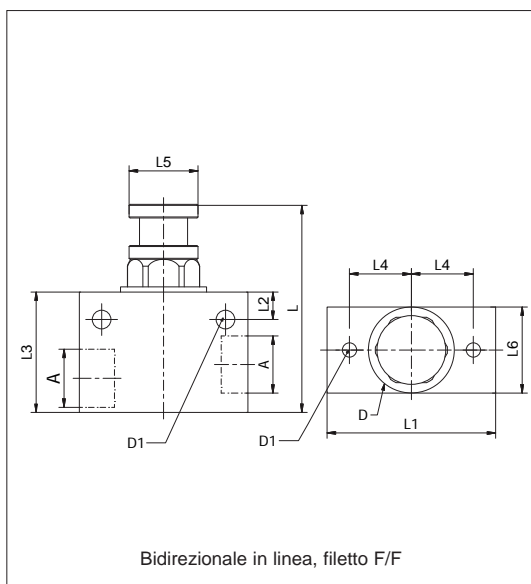

Codice	Articolo	A	L		L ₁	L ₂	L ₃	L ₄	L ₅	L ₅	D Ø	D ₁ Ø	Weight gr
			min	max									
030157	VX53 18 18	1/8"	49	54	40	8	30	15	20	20	5,4	M5	168
030158	VX53 14 14	1/4"	49	54	40	8	30	15	20	20	5,4	M5	178
030144	VX53 38 38	3/8"	57	66	49	8	35	18	20	25	5,4	M5	305
030148	VX53 12 12	1/2"	57	66	49	8	35	18	20	25	5,4	M5	310

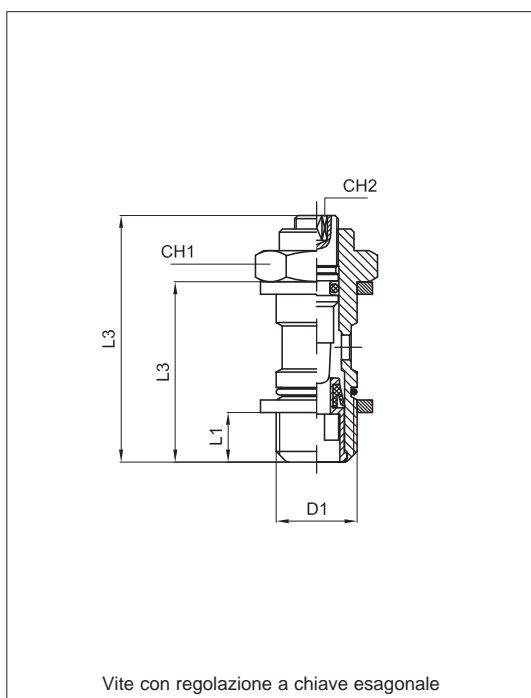

Per cilindro

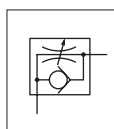

Codice	Articolo	D ₁	L ₁	L ₂	L ₃ max	CH ₁	CH ₂	Peso gr
024035	VX15 00 18C	1/8"	5,5	25	36	14	2,5	16
024036	VX15 00 14C	1/4"	6,5	27,5	42	17	3	30

Per occhielli innesto rapido serie RX

vedi pagina 5.150.5.

Bidirezionali

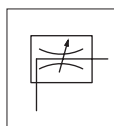

Codice	Articolo	D ₁	L ₁	L ₂	L ₃ max	CH ₁	CH ₂	Peso gr
024037	VX15 00 18B	1/8"	5,5	25	36	14	2,5	16
024038	VX15 00 14B	1/4"	6,5	27,5	42	17	3	30

Per occhielli innesto rapido serie RX

vedi pagina 5.150.5.

Per valvola

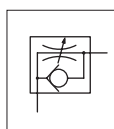

Codice	Articolo	D ₁	L ₁	L ₂	L ₃ max	CH ₁	CH ₂	Peso gr
024039	VX15 00 18V	1/8"	5,5	25	36	14	2,5	16
024040	VX15 00 14V	1/4"	6,5	27,5	42	17	3	30

Per occhielli innesto rapido serie RX

vedi pagina 5.150.5.

Per cilindro

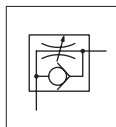

Codice	Articolo	Ø tubo	D1	D2	L1	L2	L3 max	L4	CH	Peso gr
024232	VX180418C	4	1/8"	9	5	15.5	32	19,5	9	29
024233	VX180618C	6	1/8"	12	5	15.5	32	22	9	27
024234	VX180614C	6	1/4"	12	6.5	17.5	40	23,5	10	49
024235	VX180818C	8	1/8"	14	5	15.5	32	22,5	9	31
024236	VX180814C	8	1/4"	14	6.5	17.5	40	24	10	49
024237	VX181014C	10	1/4"	16	6.5	17.5	40	26,5	10	53
024238	VX181038C	10	3/8"	16	9	22	52	28	14	86

Per valvola

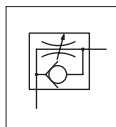

Codice	Articolo	Ø tubo	D1	D2	L1	L2	L3 max	L4	CH	Peso gr
024239	VX180418V	4	1/8"	9	5	15.5	32	19,5	9	29
024240	VX180618V	6	1/8"	12	5	15.5	32	22	9	27
024241	VX180614V	6	1/4"	12	6.5	17.5	40	23,5	10	49
024242	VX180818V	8	1/8"	14	5	15.5	32	22,5	9	31
024243	VX180814V	8	1/4"	14	6.5	17.5	40	24	10	49
024244	VX181014V	10	1/4"	16	6.5	17.5	40	26,5	10	53
024245	VX181038V	10	3/8"	16	9	22	52	28	14	86

Per bidirezionali

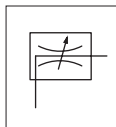

Codice	Articolo	Ø tubo	D1	D2	L1	L2	L3 max	L4	CH	Peso gr
024246	VX180418B	4	1/8"	9	5	15.5	32	19,5	9	29
024247	VX180618B	6	1/8"	12	5	15.5	32	22	9	27
024248	VX180614B	6	1/4"	12	6.5	17.5	40	23,5	10	49
024249	VX180818B	8	1/8"	14	5	15.5	32	22,5	9	31
024250	VX180814B	8	1/4"	14	6.5	17.5	40	24	10	49
024251	VX181014B	10	1/4"	16	6.5	17.5	40	26,5	10	53
024252	VX181038B	10	3/8"	16	9	22	52	28	14	86

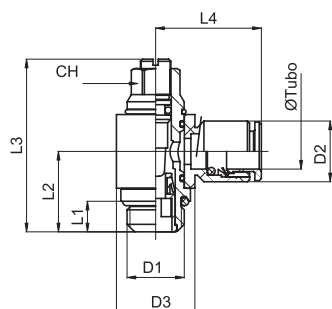

Per cilindro girevole con innesto rapido

Portate

